

SOMMERKAMP[®]

CITIZENS BAND TRANSCEIVER INSTRUCTION MANUAL



MODEL TS-712P

CONTROL LOCATIONS :

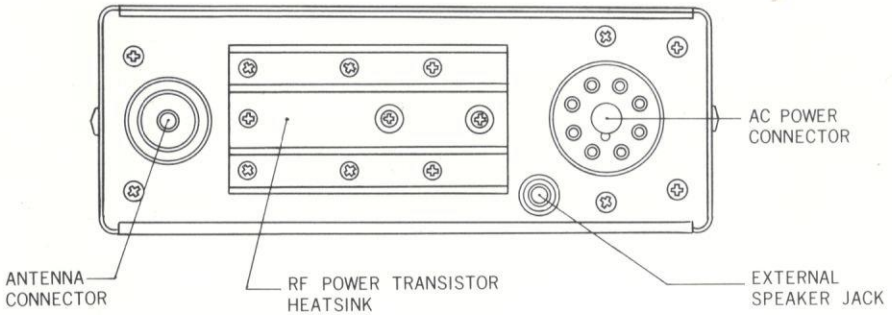
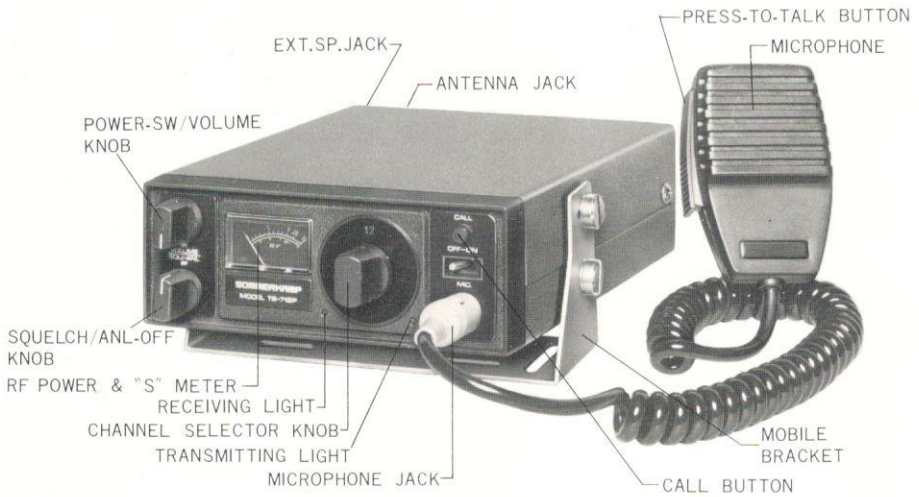

PACKING LIST :

Beside this manual, the carton shall contain the following items:

- 1 Transceiver TS-712P
- 1 Mounting bracket
- 4 Screw for Mounting bracket
- 1 Microphone hanger
- 1 AC cord with 8 pin connector
- 1 Microphone

GENERAL DESCRIPTION

Your SOMMERKAMP TS-712P transceiver has been designed for continuous heavy duty base station application. It can be operated with a microphone and internal speaker or headset, speaker/microphone combination, telephoneset incorporating automatic voice operated transmit/receive switching, external selective calling with automatic answerback and many more.

GENERAL:

The transceiver is designed to operate from 110/220 Volt AC as a base station. Its straight forward 12 channel capability allows it to operate on any combination of frequencies within 26.5 and 29.7 MHz by inserting the corresponding xtals and retuning the transceiver if required. The Xtals in the transceiver are standard 27 MHz CB Xtals with plus or minus 455 KHz receiver offset. No special synthesiser or IF Xtals are required.

RECEIVER SECTION

The receiver section is designed to receive amplitude modulated (AM/A3) signals in the 27 MHz (11 meter) citizens band. The unique combination of low noise Field Effect Transistors (FET), single conversion, a combination of mechanical ceramic, and L/C filters, fully automatic noise limiter and a hifi quality speaker amplifier will give you exceptional reception quality in this fine piece of equipment.

In addition, the above combination of the latest technology provides you with a sensitivity and unwanted signal rejection and noise suppression available previously only in space and military communication equipment.

The power supply of the receiver RF, IF and oscillator section is stabilized by an extreme sharp cut-off Zener diode to obtain the high sensitivity and unwanted signal rejection. The fully automatic series gate noise limiter, which virtually cuts off the audio output during ignition noise pulses, is defeatable to make even the weakest signal audible which otherwise would be cut off by the threshold level of the ANL switching diode.

The high squelch sensitivity is achieved by using a separate squelch detector and switching circuit with a carefully balanced hysteresis. The transformerless hifi quality audio power amplifier will drive any load between 8 ohms and indefinite such as internal speaker or external speaker/microphone or headset combinations having the above impedances.

The meter indicates the field strength during reception of a signal.

TRANSMITTER & MODULATOR SECTION:

The transmitter section is designed for continuous heavy duty transmission of amplitude modulated (AM/A3) signals in the 27 MHz. (11 meter) citizens band.

The transmitter consists of a crystal controlled oscillator. The output of this oscillator is amplified in a highly efficient collector-modulated class C driver and power output stage, coupled by series and pi-matching filters to the antenna jack.

The modulator consists of an input audio filter, ALC transistor, integrated pre-amplifier and modulation transformer. This gives you the lowest possible modulation distortion and up to 100% modulation. The input is designed for 500 to 10K ohm dynamic microphone or 8 ohm speaker/microphone combination with a 1K ohm resistor in series.

RECEIVE/TRANSMIT SWITCHING:

The receive/transmit switching is done by a single pole, single throw switch in the microphone and a combination of NPN and PNP switching transistors.

METER:

The combination meter provides you with the following functions. •
During receive mode.....it indicates the incoming signal strength.
During transmit mode.....it indicates the output power.

AC POWERSUPPLY

The AC powersupply consists of the heavy duty power transformer, a 4 diode full wave bridge rectifiers and a heavy duty voltage stabiliser for 13.5 Volt for the receiver and transmitter sections.

BASE STATION INSTALLATION AND CHECKOUT

Unpack the transceiver carefully and check for exterior damages and the accessories.

Connect the 3 wire AC cord to an AC plug in the following manner:

1. blue to AC terminal
2. brown to AC terminal
3. yellow/green to the earth terminal

Connect the antenna plug to the antenna jack with an SWR-Meter inserted into the antenna cable.

Connect the microphone to the microphone jack.

Place the transceiver in operating position and connect the AC plug to a 220 Volt 50 Hz AC outlet.

Check very carefully that nothing touches the back panel and that there is a min. 10 cm space between the backpanel and any object nearby because the transmitting transistors will heat up to 100 degree Centigrade and carry a voltage of 14 Volt DC and high power RF.

Switch the transceiver ON.

The receiving, meter and the channel lamp shall light up.

Turn the Squelch control to min. (ANL OFF)

Turn the Volume control to max. until you hear a rushing sound from the speaker.

Switch the channel selector to CH 1.

Push the transmit button on the microphone and check with the SWR-Meter immediately the SWR of your antenna. The SWR must be less than 1 to 2. Do this within 3 seconds, because if the SWR is higher than 1 to 2 it is very likely that the transmitting transistors will be damaged if you operate the transmitter too long with a antenna having a too high SWR. Also read carefully the recommendations on antennas.

If the SWR is less than 1 to 2 continue installation. If it is more than 1 to 2 repair or replace your antenna.

Check that the meter needle is near the red mark during transmitting.

Talk into the microphone. The meter needle shall move a little.

Release the transmit button and switch the channel selector to channel 1,2 ectr, until you receive a station.

Wait until this station stops to transmit and turn the Squelch control slowly to max. until the background noise just disappears. When the station starts to transmit again, you will hear this station, but you will not hear the background noise during non transmitting periods.

OPERATING INSTRUCTIONS

The transceiver is ready to operate when it is installed with an antenna properly connected. Note that the communication range differs depending upon the environment where the transceiver is operated. You may reach 30 or 40 kilometers where no obstacle exists, but the range may be limited to 5 or 6 kilometers in cities where many high buildings disturb the communication.

- 1) Turn the set on by switching the ON-OFF snup switch to ON and the channel dial will be lighted. Turn the volume control clockwise to increase the audio sound. Note that the volume control knob is only for adjusting the audio volume, not to increase the transmitting power.
- 2) Turn the squelch control clockwise until incoming noise is eliminated. Do not turn it excessively as the sensitivity may be reduced.
- 3) Turn the squelch control counter-clockwise to switch off the ANL (Automatic Noise Limiter)
- 4) Turn the channel selector knob to the desired channel.
- 5) For transmitting, press the button on the microphone and speak into it normally. Release the button for receiving.

METER

The meter reading indicates the signal strength at receiving, and functions as an output indicator at transmitting, and the meter pointer should be within the Red zone under the normal conditions.

MICROPHONE JACK

The 7-pin DIN standard accessory jack has the following internal connections:

- | | |
|-------------------------------------|--------------------------------|
| 1. Internal speaker | 5. N/C |
| 2. AF.out for selective call. | 6. +12V for VOX unit etc. |
| 3. Audio output (Z 8 ohm-10K ohm) | 7. Transmit/Receive switching. |
| 4. Microphone input (Z 600-10K ohm) | Case = ground |

Always operate the transceiver with the microphone plug inserted in the microphone jack, or with the following external connections:

1. Microphone with VOX

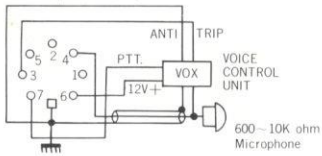

5. External microphone/speaker with PTT.

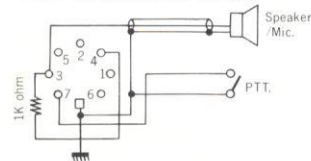

2. Headset or Telephoneset with PTT.

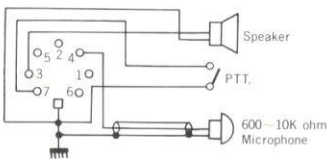

6. Internal connection

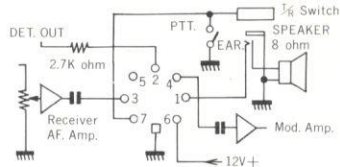

3. External microphone

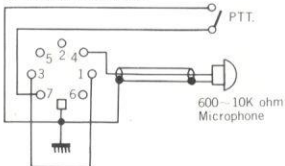

7. Parrot 76

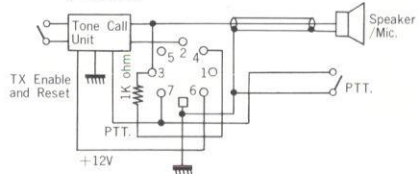

4. Headset or Telephoneset with VOX

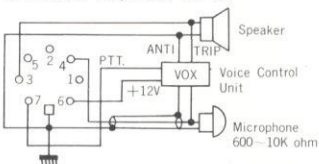

SCHEMATIC DIAGRAM

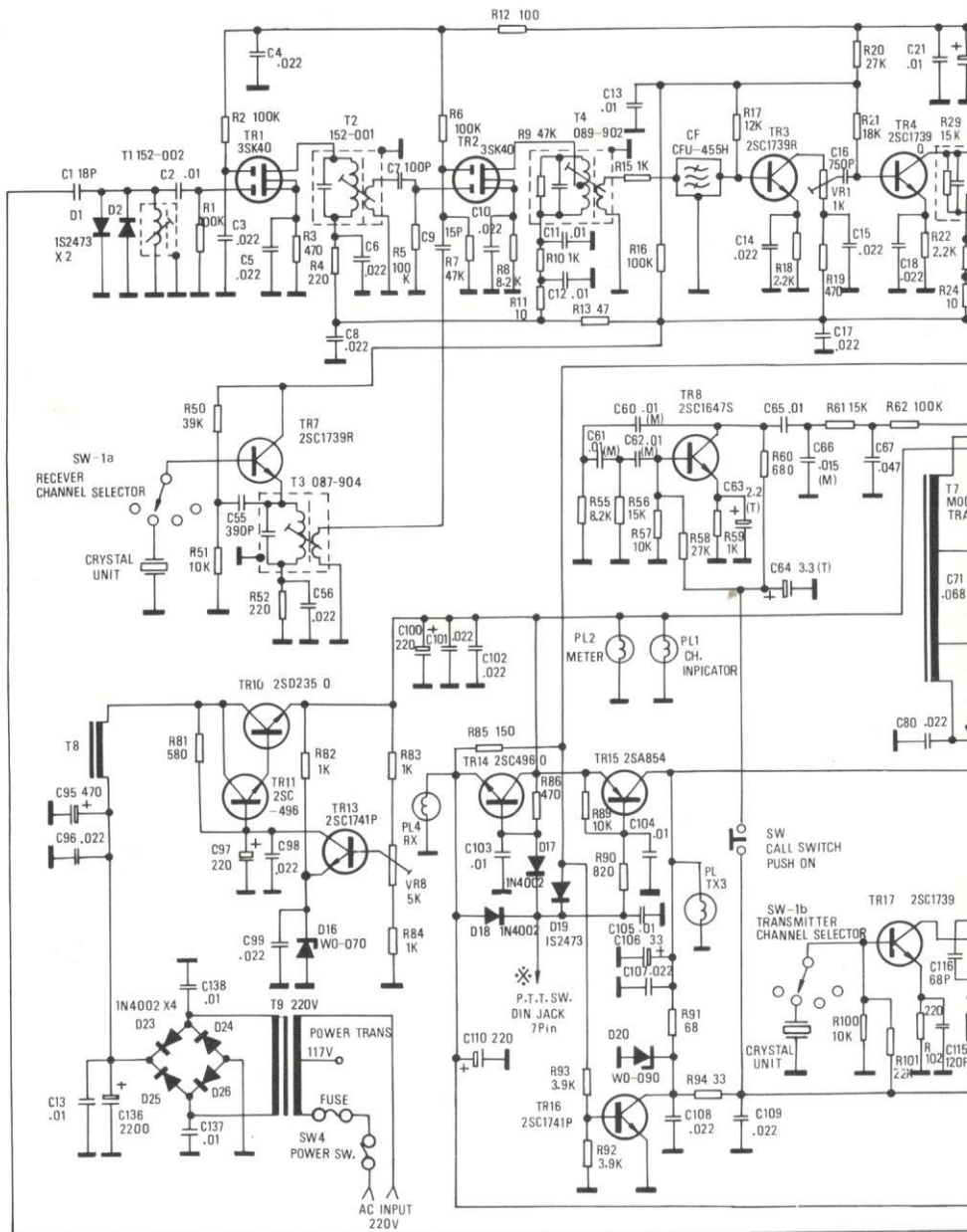

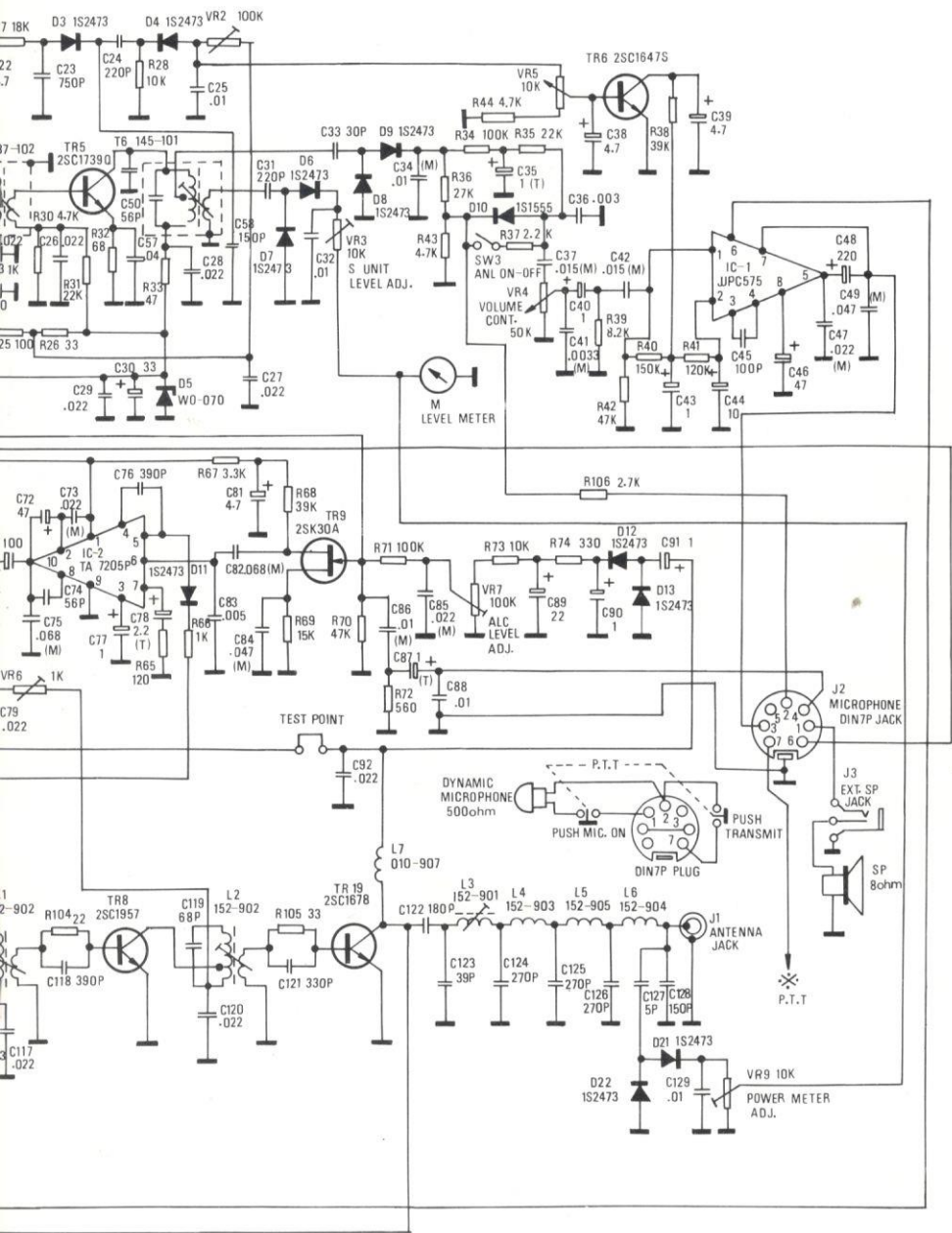

MAIN PARTS LAYOUT

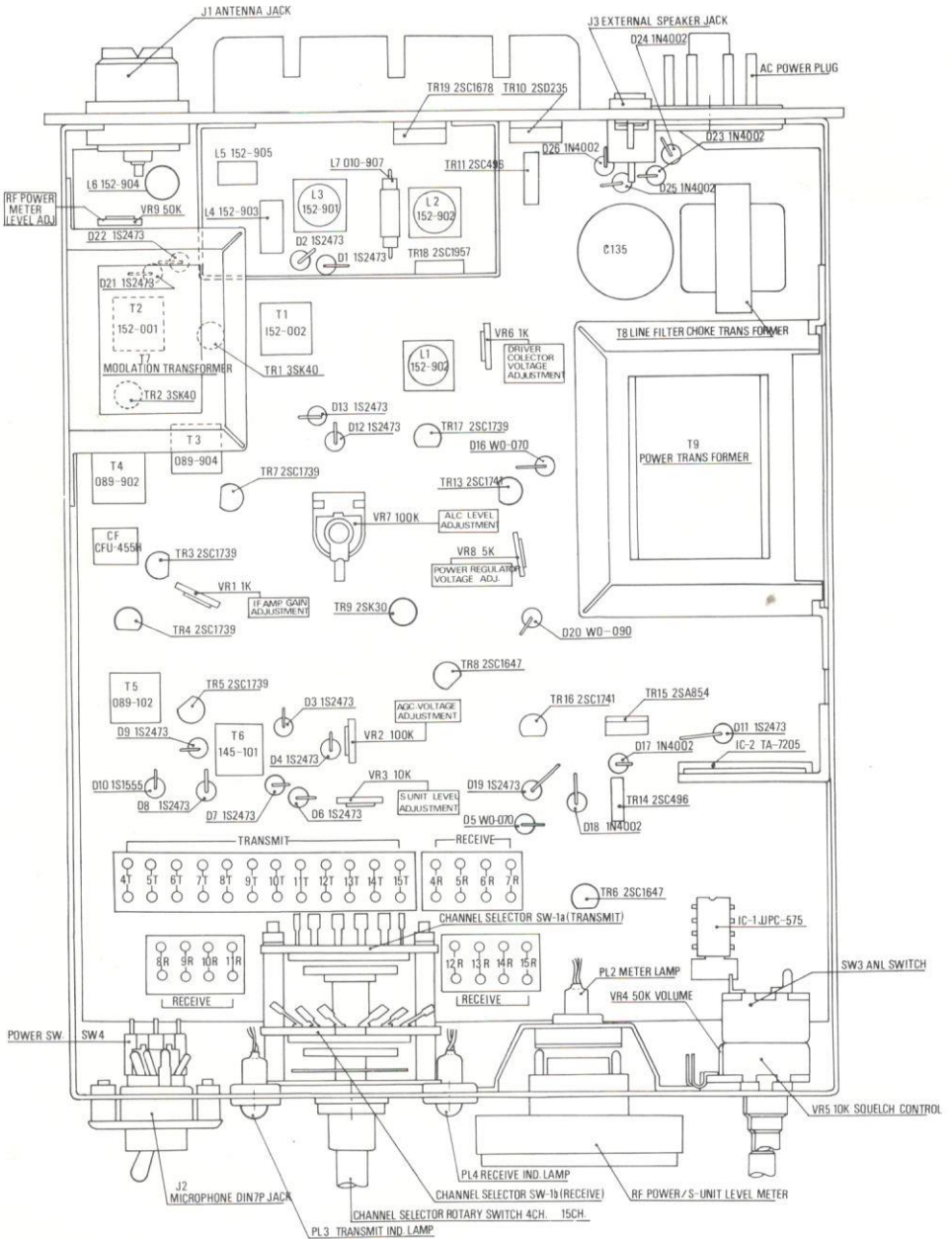

PRINTED CIRCUIT BOARD PARTS LAYOUT

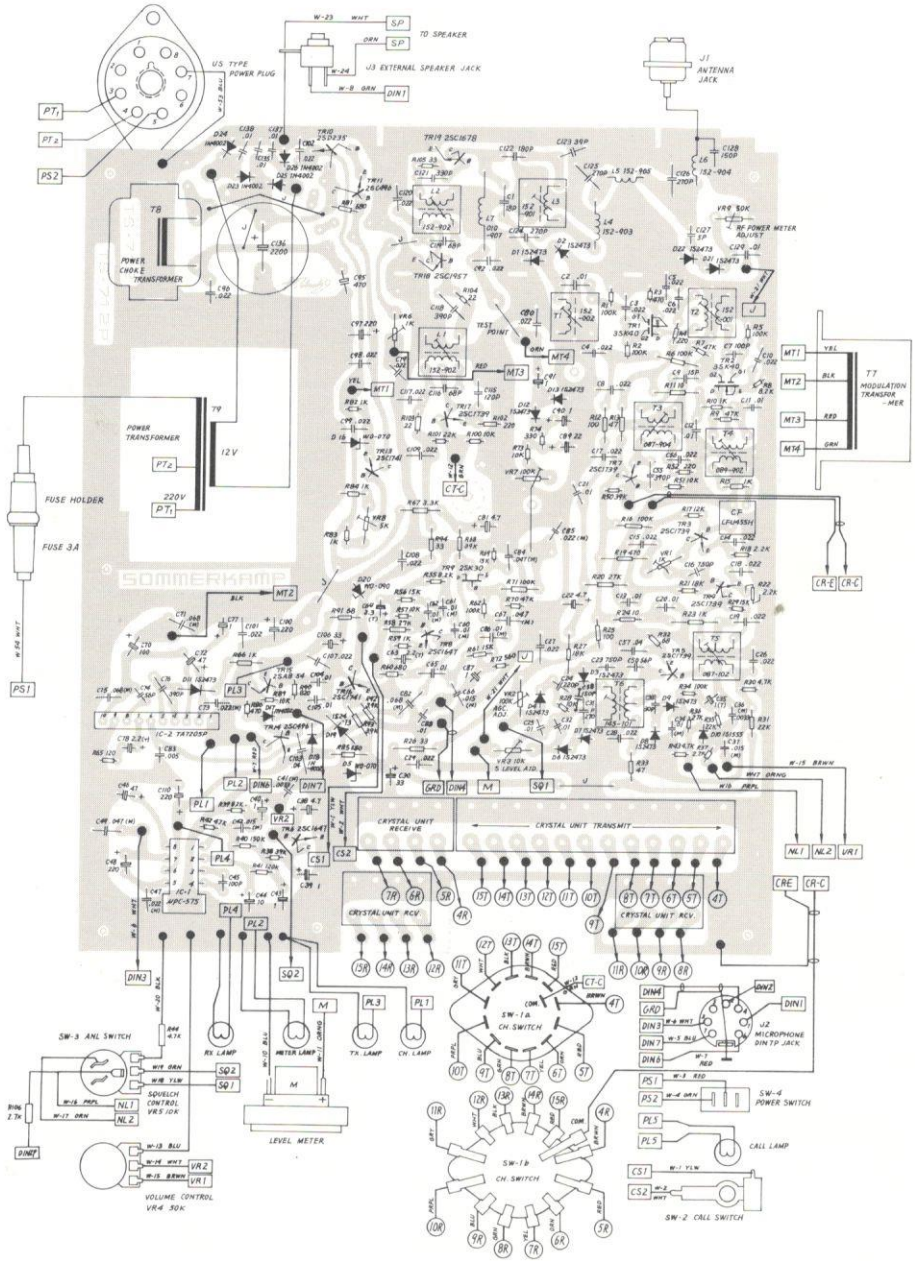

BLOCK DIAGRAM

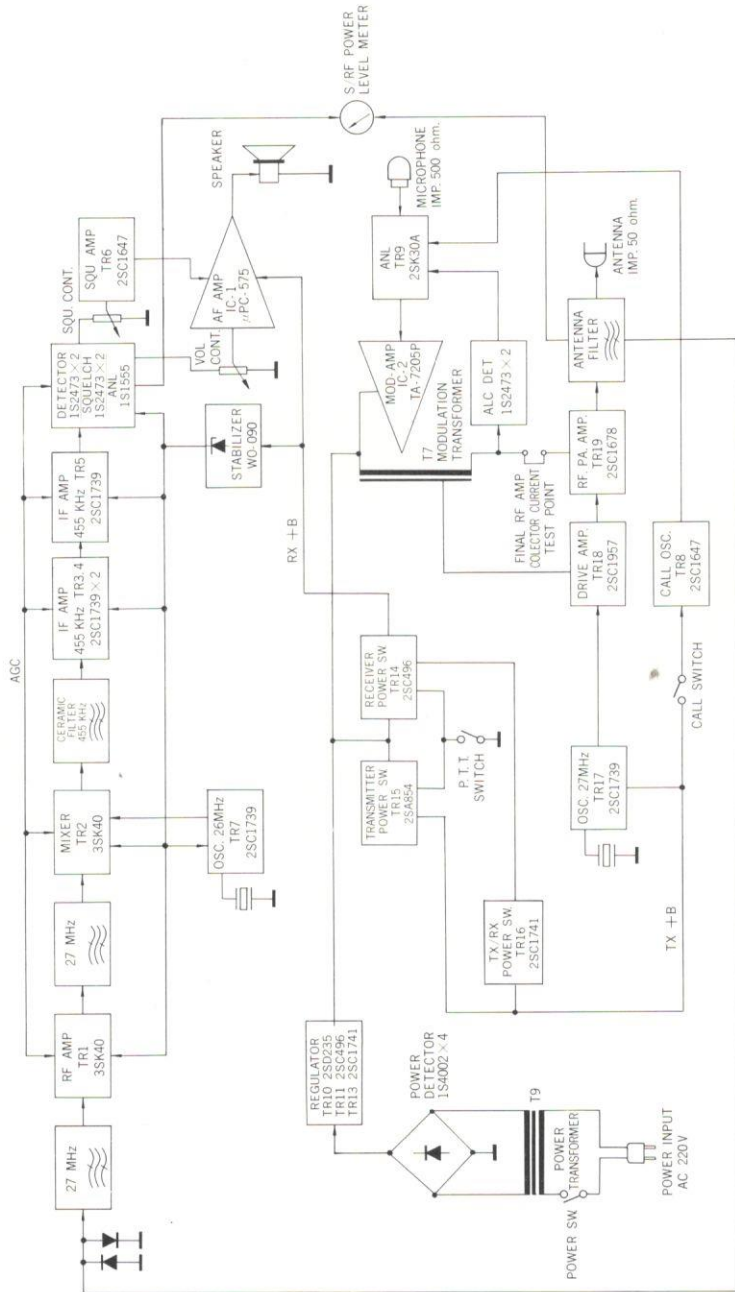

PARTS LIST for TS-712P

DESIGNATION	PARTS NAME	PARTS NO.
MP-201B	Front Frame.	483014- SB
MP-202B	Chassis Frame.	502035
MP-351B	Back Pannel.	494257- B
MP-105	Cabinet Cover (Upper).	483016
MP-124	Cabinet Cover (Lower).	502034
MP-107	Mounting Bracket.	484085
MP-303	Front Plate (L).	494187- L
MP-350	Front Plate (R).	494258
MP-401	Brand Plate.	504336
MP-402	Back Plate.	504327
MP-110	Mounting Bracket for Meter.	484064
MP-403	Heatsink for IC.	504329
MP-353	Heatsink for 2SC1237 (2SC1678) A.	494251
MP-354	Heatsink for 2SC1237 (2SC1678) B.	494252
MP-211	Meter Lamp Reflection Plate.	484063
MP-212	Channel Indicator Screen.	484107
MP-214	Mounting Bracket for Channel Lamp.	484108
MP-111	Call Switch Contact.	484086
MP-112	Call Switch Spring.	484087
MP-117	Knob for Channel Selector.	484116
MP-17	Knob for Vol./Squ. Control.	474011
MP-118	Nut for Channel Selector.	484073
MP-120	Screw for Mounting Bracket.	484098
MP-404	Channel Indicator Plate.	504325
MP-405	Heatsink for 2SC1957	504328
MP-19	Call Button.	484056
MP-406	Mounting Bracket for Speaker.	504335
MP-109	Supporter for MIC. Consent.	484084
J1	Antenna Jack	MRM/INCH
J2	Microphone Jack DIN Type 7P.	CS279
J3	EXT. Speaker Jack.	SJ- 296
VR5	Variable Resistor (Volume) 50K ohm	VR1650KB
VR4	Variable Resistor (Squelch) 10K ohm	VR1610KBS
VR1	Semi Valiable Resistor 1K ohm	SVR001KS3
VR6	Semi Valiable Resistor 1K ohm.	SVR001KS2
VR8	Semi Valiable Resistor 5K ohm.	SVR005KS3
VR3	Semi Valiable Resistor 10K ohm.	SVR010KS2
VR9	Semi Valiable Resistor 10K ohm.	SVR010KS3
VR2	Semi Valiable Resistor 100K ohm.	SVR100KS2
VR7	Semi Valiable Resistor 100K ohm.	SVR100KF
L1	TX. OSC. Tuning Coil.	152- 902
L2	TX. Buffer Tuning Coil.	152- 902
L3	TX. Final Tuning Coil.	152- 901

PARTS LIST for TS-712P

DESIGNATION	PARTS NAME	PARTS NO.
L4	TX. Filter Coil.	152-903
L5	TX. Filter Coil.	152-905
L6	TX. Filter Coil.	152-904
L7	TX. Final Choke Coil.	010-907
T1	RX. RF Tuning Coil.	152-002
T2	RX. RF Amp. Tuning Coil.	089-902
T3	RX. Local OSC. Coil.	087-904
T4	I. F. T. 455 KHz 1st.	089-902
T5	I. F. T. 455 KHz 2nd.	087-102
T6	I. F. T. 455 KHz 3rd.	145-101
T7	Modulation Transformer.	E1-42-712P
T8	Power Filter Choke Transformer.	E1-25-732P
T9	Power Transformer.	E1-57-732P
TR1, 2	FET	3SK40
TR 9	FET	2SK30A
TR4,5,7,3,17,	Transistor	2SC1739-Q
TR13, 16	Transistor	2SC1741-P
TR6, 8	Transistor	2SC1647-S
TR14, 11	Transistor	2SC496-O
TR18	Transistor	2SC1957
TR19	Transistor	2SC1678
TR10	Transistor	2SDZ35-O
TR15	Transistor	2SA854-Q
D1-9, 11~13, 19, 21, 22	Silicon Diode	1SZ473
D10	Silicon Diode	1S1555
D17, 18, 23~26	Silicon Diode	1N4002
D16	Zener Diode	WO-070
D5, 20	Zener Diode	WO-090
IC-1	Integrated Circuit.	UPC575 C2
IC-2	Integrated Circuit.	TA7205P
SP	Speaker.	SP-77-8
PL1, 2	Pilot Lamp.	PL-14-80
PL3, 4	Pilot Lamp.	PL-12-40
CF	Ceramic Filter.	CFM-455H
EP-203	Socket for Crystal Unit 4P	XS-4P
EP-503	Socket for Crystal Unit 12P	XS-12P
EP-502	AC. Power Cord	W-732AC
F1	Fuse 3A	F-3A
SW-1a~1b	Channel Selector Rotary Switch.	SRM-2-2-12
M	Meter	D33B35R
MIC.	Microphone	22-256-28
SW4	Power Toggle Switch	8A-2011

Specification for TS-712P

Semiconductor:	2 Integrated Circuits, 3 FET, 15 Transistors, 22 Silicon diodes, 3 Zener diodes.
Transmitter System:	Crystal controlled. Collector modulation AM.
Frequency:	12 Channel on 27 MHz Band.
Input Power:	0.5 Watts. (3 Watts).
Band Width:	8 KHz (max).
Antenna Impedance:	50~52 ohm.
Receiver System:	Single conversion superheterodyne. Crystal controlled.
Sensitivity:	1 μ V or better for 500 mW output. 10 dB signal to noise ratio.
Intermediate Frequency:	455 KHz.
Selectivity:	30 dB down at 10 KHz.
Squelch Sensitivity:	1 μ V
Audio Output Power:	2W watts in 10% distortion.
Power Source:	220V AC.
Fuse:	3A.
Microphone:	Dynamic type Impedance 500 ohm. with Press-to-talk switch.
Speaker:	Dynamic type voice coil impedance 8 ohm.
Size:	156 × 58 × 205 m/m.
Weight:	2.3 kg.
Accessories:	Mounting bracket, Mounting hard ware, AC power cord, Microphone hanger.

SOMMERKAMP ELECTRONIC SAS

CH-6903 LUGANO, P.O. BOX 176

SWITZERLAND

TEL.91 688543 TELEX:79314